



AFX Series

AC, DC, AC+DC and DC+AC Power Sources
Single and Three Phase AC Power Sources
All Digital Power Conversion Technology

Extensive Features:

- Three Phase, Split Phase and Single Phase Output Modes
- AC, DC and AC+DC Output Capability
- Uninterrupted Switching between AC and DC Outputs in AC+DC mode
- Constant Power Mode Voltage Range to 300Vac L-N/520Vac L-L or ± 425 Vdc.
- Extended voltage range operation to 333Vac/576Vac
- No need to switch between high and low voltage ranges
- Frequency Range DC, 15 - 1200Hz, Extended Frequency Range DC, 1Hz to 3000Hz.
- Phase Angle Programming
- Active Three Phase PFC input with Inrush Current Limiting
- Precise Output Voltage and Load Regulation
- Metering of Volts, RMS Current, Peak Current, Apparent Power & True Power on all Phases
- Harmonic Measurements
- Scope Function to capture Voltage & Current waveforms
- Sine, Square, Triangle, Clipped Sine and Arbitrary Waveforms Selections
- Output LIST, PULSE and STEP Mode Transient Programming
- Unique Sleep Modes Save Energy, Reduces needless Heat Generation and Extends the Life of the Power Source
- Standard USB, LAN, RS232 & GPIB Interfaces
- IEC61000-4-13 Interharmonics Generator Option

6 kVA/kW to 180 kVA/kW

AC: 0-333 V_{AC} L-N 1 ϕ / 0-666V_{AC} L-L 2 ϕ
/ 0-576 V_{AC} L-L 3 ϕ

DC: -425Vdc to +425Vdc

Frequency: DC, 1 - 3000 Hz

NEW "A" VERSION



"Innovating Solutions for Control and Monitoring of Power"



Patented Technology

THE POWER OF EXPERTISE



FREQUENCY CONVERSION

AEROSPACE

R & D

MILITARY

MANUFACTURING

CUSTOM

Total Control, Metering and Analysis of AC or DC Power.

Control

PROGRAM				Apply All
Freq.	400.00 Hz			Unlink Phases
Phase	Phase A	Phase B	Phase C	
	0.00	120.0	240.0 Deg	
Volt. AC	115.00	115.00	115.00	Protection
Volt. DC	0.00	0.00	0.00	
Curr. lim.	41.67	41.67	41.67	Peak Control
Pow. lim.	4.60	4.60	4.60	
kVA lim.	5.00	5.00	5.00	Waveform
	Ready	Prog. MAN	LOC 3ph	

Metering

MEASUREMENTS 1 OF 2				Meas. Page 2
Freq.	400.00 Hz			Fault Status
Phase	Phase A	Phase B	Phase C	
	115.00	115.00	115.00	
Volt. L-N	115.00	115.00	115.00	Error and Event
Current	25.67	25.67	25.67	
Power	2.655	2.555	2.655	Real Time Plot
	V _{AB}	V _{BC}	V _{CA}	
Volt. L-L	199.20	199.19	199.20	Individual Phase
	Ready	Prog. MAN	LOC 3ph	

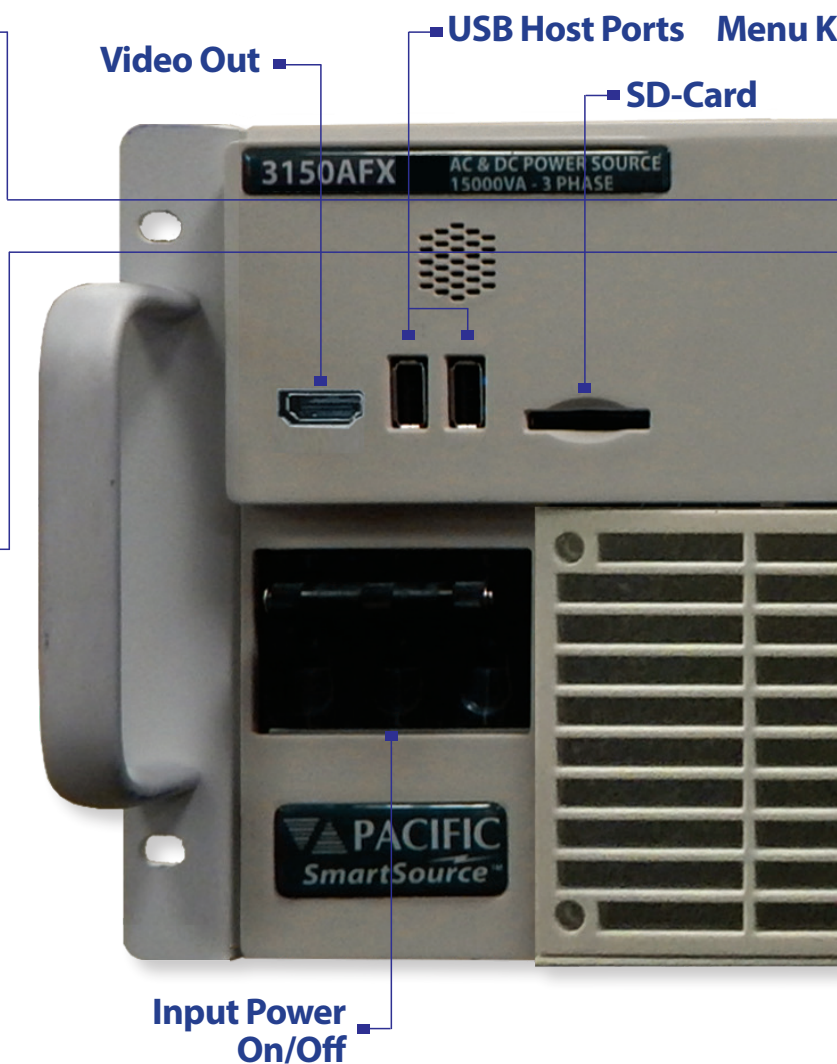

Automated Test Equipment Power for Defense Applications

Growing demand for power to support increasingly complex avionics, radar and weapons systems means more power is needed in less available space. The new AFX Series addresses this need by offering power density three times higher than it's nearest competitor.

With extensive control over voltage, current, frequency, phase angles and transients, the AFX series is capable of handling complex Test Program Sets (TPS's) with minimal programming effort. It's AC and DC operating modes provide support for both AC and DC powered equipment providing greater flexibility.



Simple, Intuitive Operation



Commercial Avionics Power Test

The advanced digital power conversion technology used in the AFX Series Power Source results in higher power density than any other offering. A wide frequency range¹ of 1Hz to 3000Hz supports both 400Hz fixed frequency as well as 360Hz to 800Hz wild frequency development and test. For DC power systems, multiple 270Vdc outputs can be used to simulate at 540Vdc aviation DC power bus.

High power, three-phase power configurations are available to match ever increasing power test demands. As needs change over time, additional auxiliary units can be added easily to keep up with your test needs while protecting your original investment.



Note 1: Extended frequency range available on direct coupled voltage ranges only.

Powerful yet Easy to Use

Although AFX Series sources offer a wide range of operating modes and features, they are easy to operate through a large full color LCD display and soft key driven menus.

Top level menus are always available directly by pressing

any of the five menu keys on the left of the display. Entering setup data is accomplished using the numeric keypad or the shuttle. Operating status is shown on screen using various colors to distinguish between setting, measurements and operator warnings, or error messages.

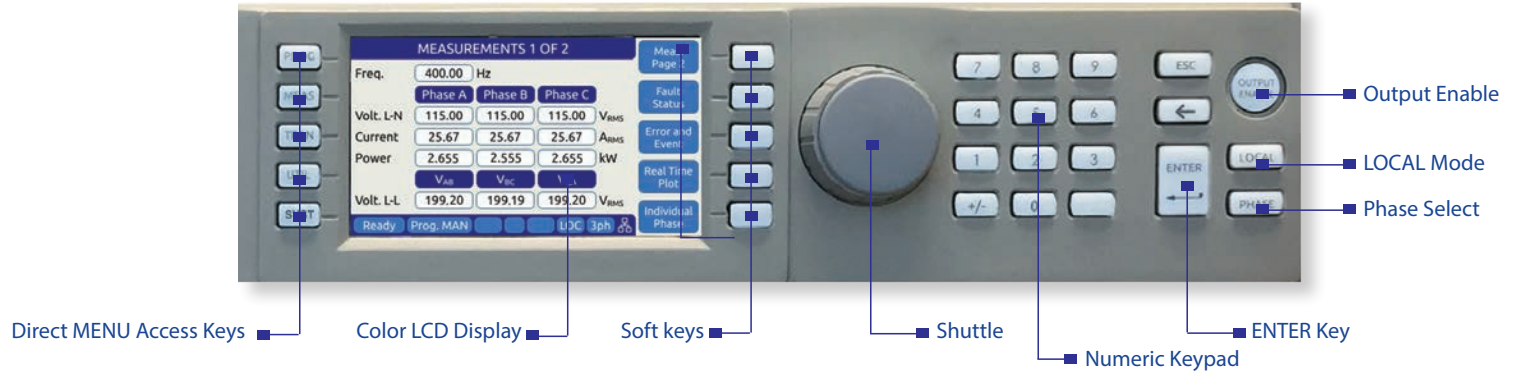

200 Selectable Arbitrary Waveforms

In addition to sine wave, the AFX Series offers multiple selectable AC waveforms such as clipped sine wave at various distortion levels, square, triangle and stepped squares. The operator can create arbitrary waveforms using Pacific Power's PPSC Studio Windows software or using a web browser and download these to the power source. A graphical representation (preview) of each waveform is shown on screen and a waveform name alias can be assigned to each so the operator can be sure the correct waveform is applied to the unit under test.

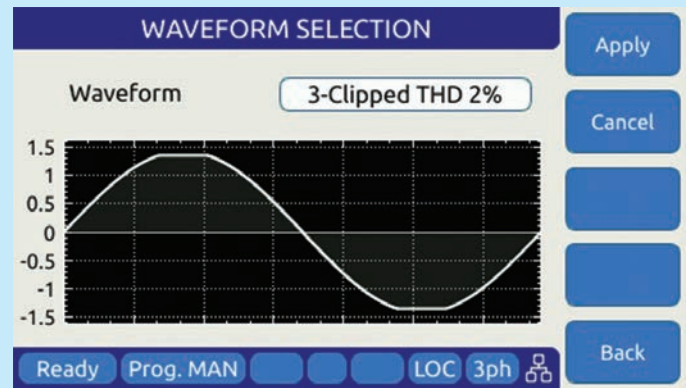

AC Waveform Selection - $V_{thd} = 2\%$

Single Voltage Range with Constant Power Profile

Traditional AC power sources use two voltage ranges to provide either high voltage or high current. By contrast, the AFX Series uses a unique single voltage range that operates along a constant power curve. This provides more current at low voltages, eliminating the need to switch between voltage ranges and provides a much wider operating range (demonstrated as green in the figure to the right). Switching voltage ranges on other AC sources causes the output to be turned off and the EUT to shut down. This makes it difficult to test universal wide input range AC products. The blue line and green shaded area in the chart shows the additional operating range available compared to a conventional AC power source with a 150V/300V range pair. Extended AC Voltage Mode can be enabled to support 333V_{LN}/576V_{LN}. See page 9.

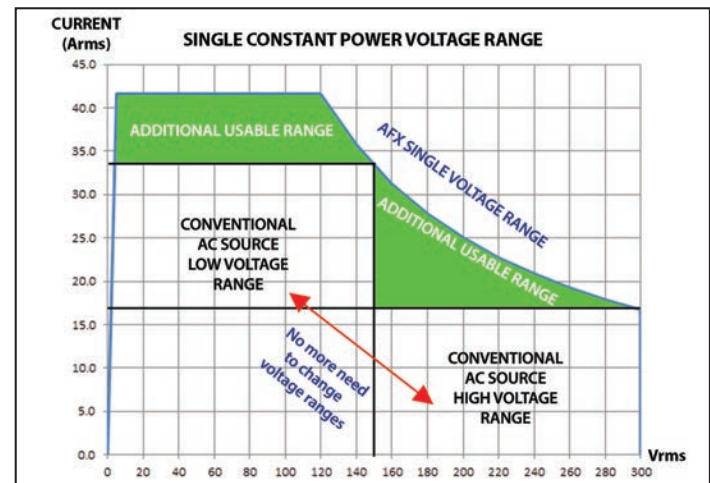

Extended Operating Range for model 3150AFX along Constant 5 kVA per Phase Power Curve. Other models have same profile but other current levels.

The same applies to DC mode of operation where a single 425Vdc voltage range is used to provide both high DC current and DC voltage.

Capture Voltage & Current Waveforms

Built-in digital scope function captures voltage and current time domain signals, perfectly synchronized to the output frequency. Voltage and current displayed with accurate phase relationship. Display output waveforms on front panel or in Web browser.

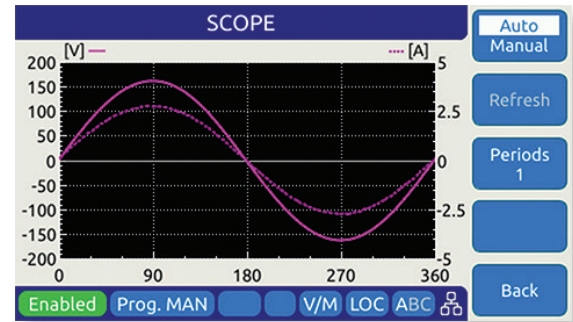

Harmonics Measurements

Eliminate the need for an external power analyzer by measuring voltage and current harmonics. Harmonics information is displayed in either bar charts or detailed table format for easy viewing and analysis.

Data is displayed for individual phase or all three phase simultaneously.

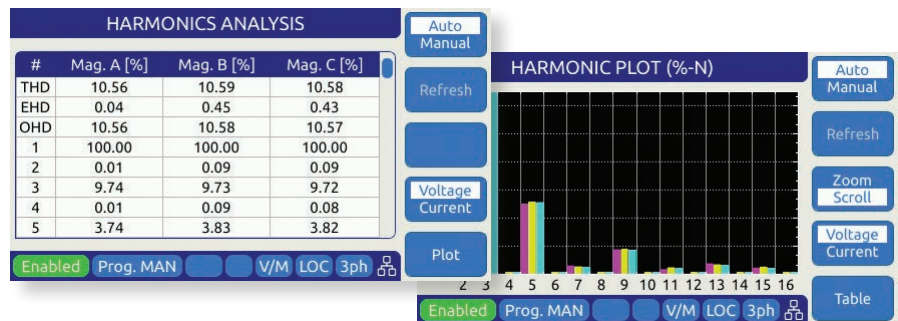

Touch Screen and WiFi Connection

The standard external HDMI Monitor interface supports the use of an external flat panel touch monitor for display and control of the power source. This allows measurements to be monitored from across the lab or factory floor as needed.

Alternatively, a tablet or smart phone can be used to operate the power source using the built-in LXI browser interface. Of course, extensive safety protocols are in place to prevent unauthorized access via WiFi or LAN connections.



Embedded Web Server & LXI Compliant LAN Interface

The AFX has a built-in web server that supports an operator friendly user interface from a web browser including Google Chrome™, Mozilla Firefox™. Available on all AFX models and also supported via the standard USB interface. The web server supports the following functions using a variety of clearly laid out screens:

- Home page with system information and interactive command line for sending SCPI commands
- Program settings and measurement read back
- Protection mode setting page
- Waveform selection page with waveform preview mode
- Transient data entry and Execution screen using spreadsheet style layout

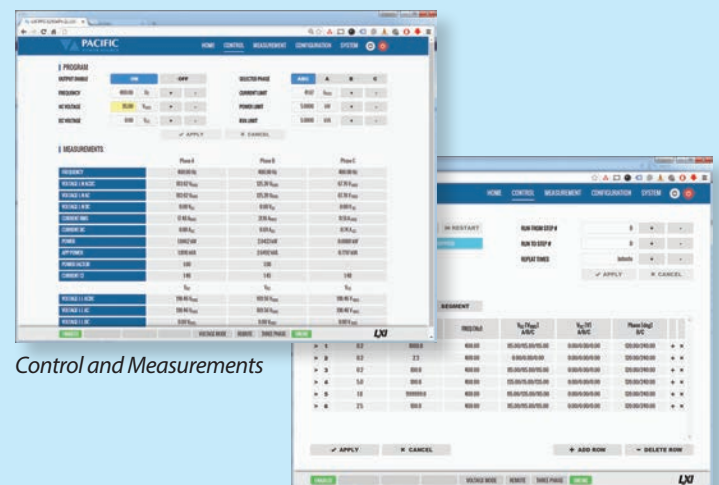

Control and Measurements

Transient Edit and Execution

Transient Programming for AC Power Test Applications

Voltage, Waveform and Frequency output transients are easily created from the front panel using an intuitive spreadsheet style data entry method. Data may be entered for a specific phase or for all three phases at the same time.

The AFX Series supports LIST, PULSE and STEP Mode Transient Types. The user can select the most appropriate type from the front panel or the web server interface. The image below illustrates the three modes graphically. Transients can be stored in non-volatile memory and easily edited as needed on screen.

If preferred, transient programming and execution can be also be accomplished using the available Windows control software or web browser interface.

TRANSIENT VIEW				
#	Freq	Volt AC	Volt DC	Dwell
1	400.00	115.00	0.00	100.0
2	400.00	100.00	0.00	10.0
3	400.00	115.00	0.00	100.0
4	400.00	100.00	0.00	10.0
5	400.00	115.00	0.00	100.0
6	400.00	100.00	0.00	10.0
7	400.00	115.00	0.00	100.0
8	400.00	100.00	0.00	10.0

Ready Prog. MAN LOC 3ph Run Screen

Transient Executing in View Mode



TRANSIENT LIST MODE

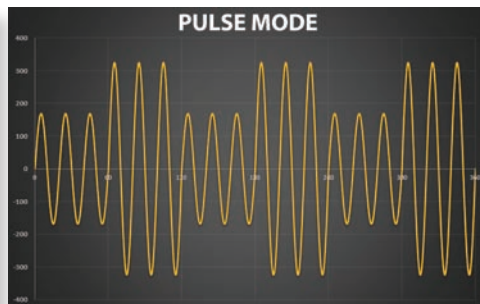

TRANSIENT PULSE MODE

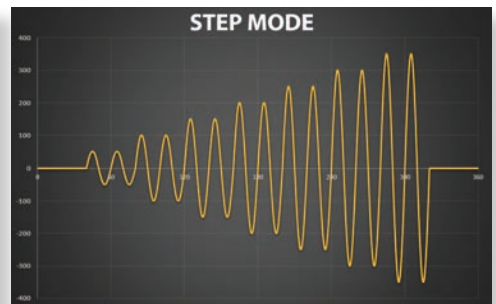

TRANSIENT STEP MODE

The AFX Series' rich feature set supports a wide variety of AC power test applications. With full control over voltage, current, frequency, power, slew rates and phase angles, no test requirement is too challenging for the AFX to handle. This includes AC power compliance testing, transformer testing, appliance testing, DC charger testing, UPS testing and more. With scalable power configurations, test needs can grow over time without having to re-invest in new AC power sources as auxiliary units can be added to an existing AFX system at any time. The scope images shown here capture several examples of AC power test waveforms generated by a 3150AFX.



Three Phase Unbalance Voltage Test Captured

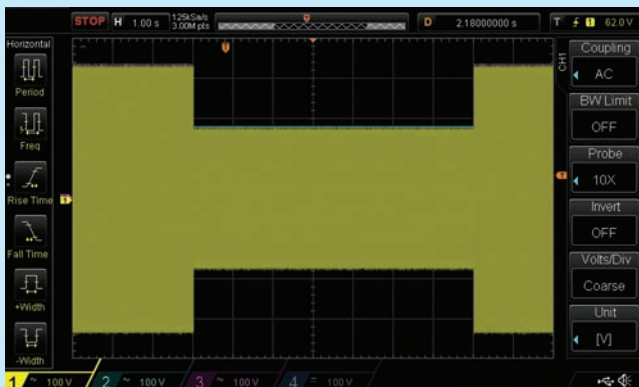

Three Phase Voltage Drop Test Captured

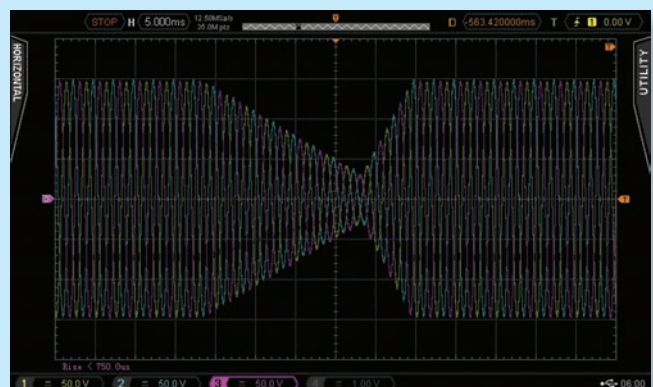

AC Transient Output Captured on Digital Scope

Transient Programming for DC Power Test Applications

The AFX Series doubles as a DC power supply with either a single DC output (FORM1) or up to three individual bipolar (2-Quadrant) DC outputs. Available voltage range is 425Vdc and the same constant power range technology is used to provide a wide operating range for diverse DC voltage and current requirements. See Volt/Current Chart on the right.

Transient programming covers DC levels and slew rates as is the case for AC applications but there is no frequency to program.

Programmable voltage slew rate settings may be used to control the rise and fall time of any DC voltage change. The scope images shown here capture examples of DC voltage ramps performed at a specific slew rate set on the 3150AFX.



DC Voltage Ramp Up @ 100Vdc/ms programmed slew rate Captured

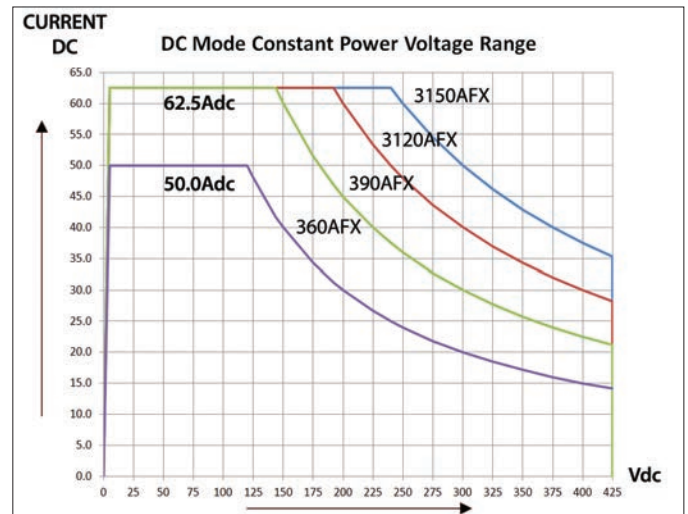

DC current vs. Voltage for 360AFX ~ 3150AFX models in single phase mode

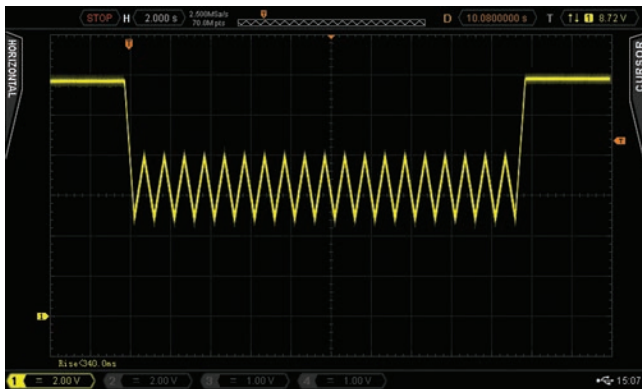

DC Voltage Transient Output Captured



DC Voltage Ramp Down @ 100Vdc/ms programmed slew rate into 100Ω resistive load captured



Unique AFX Features & Benefits

The AFX Series is based on a truly revolutionary technology platform that enables functionality not previously found on programmable AC and DC source products from any other manufacturer. These features help address a wide range of applications while at the same time providing a higher level of protection for the unit under test.

Compact Size

Featuring the highest power density available today, the AFX fits in small spaces allowing power upgrades of existing power test stations without the need to deploy more cabinets or floor space. In today's environment of space efficiency and optimal resource utilization, this is a significant benefit.

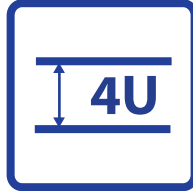

Light Weight

The 15 kVA 3150AFX weighs in at less than 51 Kg offering an incredible 295 VA of power output per kilogram. This not only saves a significant amount of money on shipping cost, it also makes the power source easy to install in a cabinet or move from one bench to another. For facilities that have a maximum floor weight rating, higher power systems can be configured using multiple AFX units that any other AC power system available today without exceeding floor loading limitations.



Small LRU Size

The unit size of a single AFX unit offers a Line Replaceable Unit size of only 15 kVA. This means enhanced flexibility in critical higher power uptime applications as the LRU replacement size is relatively small compared to typical 45 kVA or 90 kVA cabinet systems. The Mean-Time-To-Repair (MTTR) for an AFX system is low which ensures less down time and provides greater productivity while minimizing lost revenue. For added piece of mind, add a redundant Master unit to any cabinet system using the Dual Master (DM) option.

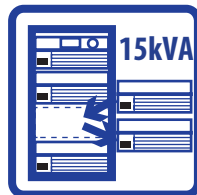

Single Voltage Range

The single 333V AC or 425V DC range of the AFX allows continuous operation of wide AC input EUTs without the need to switch voltage ranges on the power source. This means no loss of output during range changing. For applications where more than 150Vac or 212Vdc are required, there is no need to give up half the available AC or DC current as it typical of conventional power sources. For example, DO160, section 16 test 16.5.2.3.1 abnormal surge voltage to 180Vac L-N can support almost twice the current compared to other manufacturer's power sources of the same VA rating.

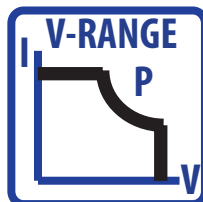

Enhanced Protection Modes

Not only does the AFX offer programmable current limit protection mode, it goes far beyond this by adding:

- Constant Voltage Protection
- Constant Current Protection
- Peak Current Protection
- True Power Protection
- Apparent Power Protection
- Over Voltage Protection
- Internal DC Bus Voltage Protection
- Over Temperature Protection



The power protection modes found on the AFX support unusual applications like Capacitor testing, Inductor testing or testing of EUT with a constant power input profile.

Legacy Software Support

To ensure our customers retain their investment in test software, the AFX Series supports a UPC controller compatibility mode that allows legacy test software to run with a new AFX power source. This includes the ability to use the existing UPC Studio Windows control software and UPC Test Manager as well as the AFX specific PPSC Studio software.



Energy Savings Modes

The unique two-stage sleep mode supported on the AFX not only save on energy costs, they also benefit the environment, ensure whisper quiet operation during periods of inactivity between tests, and prolong the life of the power source.



POWER FLEX Program

Never worry about running out of power. With the available POWER FLEX upgrade program, you can turn your 6kVA AFX into a 9kVA, 12kVA or even a 15kVA unit without having to buy another one. Just return it to one of our service centers and we will upgrade your unit to a higher power model. Never worry about future power increases again.



Extended AC Voltage Range Mode

The extended voltage operation mode allows higher voltage output programming when enabled. This allows the standard AFX power source to address additional high voltage test requirement than would otherwise be possible. This extended range increases the maximum output voltage to 333Vac L-N / 576Vac L-L over a frequency range from 45Hz to 800Hz. This supports over voltage testing up to 20% for 480V nominal powered equipment. It also allows testing of single phase universal 90V ~ 265V AC input products to 120% of their maximum nominal input specification.

Note that voltage distortion above 300V L-N may exceed standard specifications in this mode as supplemental specifications will apply. Typically, V_{thd} ranges from 0.5% @ 300V to less than 3.0% @ 333V in this operating mode.

For test requirements higher than 333V_{LN}/576V_{LL}, refer to the available Transformer output option that supports testing to 600V_{LN}/1000V_{LL}.

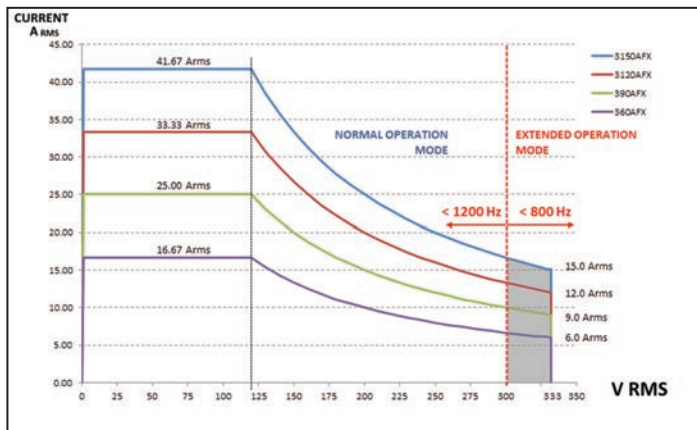

Three Phase Mode Extended Voltage Range Constant Power Profile

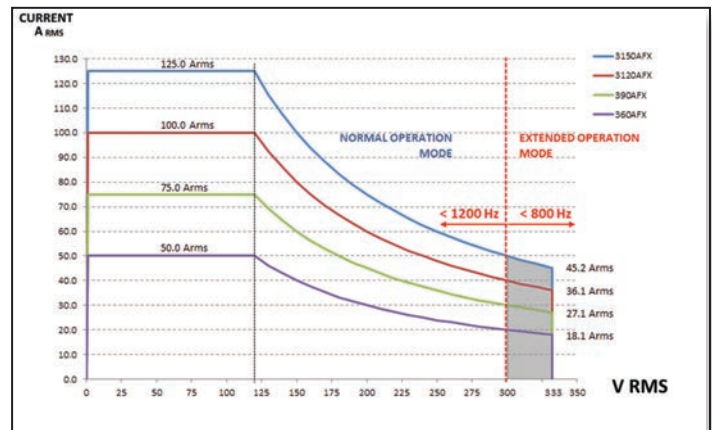

Single Phase Mode Extended Voltage Range Constant Power Profile

Extended Frequency Range Mode

The available extended frequency range mode allows operation beyond the 15 to 1200 Hz full specification bandwidth. Extended mode allows operation from 1Hz to 3000Hz with some power or voltage derating. The allowable voltage, current and power profiles for three

phase mode from 1200~3000Hz are shown in the two graphs below. For operation below 15Hz (1~15Hz), only power output is derated as shown in the third graph. As is the case for Extended Voltage mode described above, supplemental voltage distortion specifications apply.

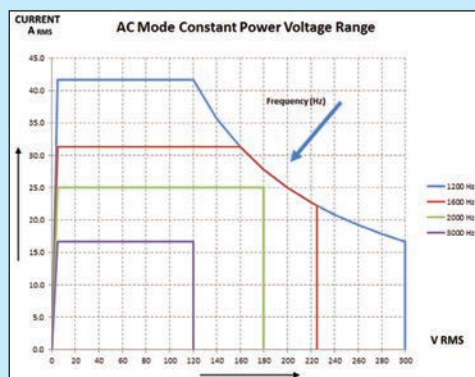

Three Phase Mode 1200~3000Hz Freq. Voltage Range

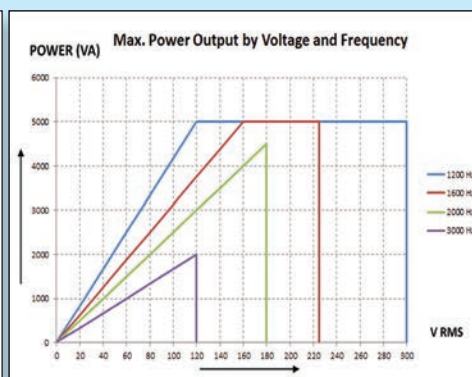

Three Phase Mode 1200~3000Hz Freq. Range Power

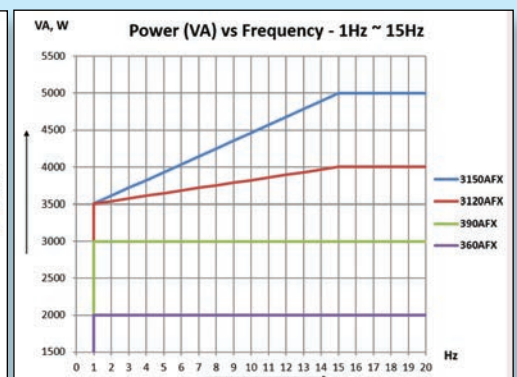

Three Phase Mode 1~15Hz Freq. Range Power

Over Current Operation Mode

When enabled by the operator, current overload mode allows up to 30% more RMS current to be delivered to the load for a short period of time. This allows riding through momentary overloads or inrush currents without triggering current protection modes in some applications. For up to 2 seconds, current protection is disabled as long as the load current is less than 130% of rated current for the mode and voltage setting.

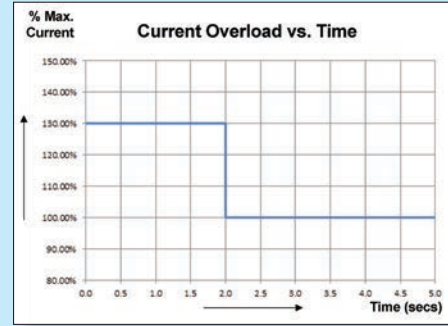

Current Overload Mode Profile

Programmable Impedance

Available programmable Output Impedance allows programming of output R and L components. User selectable modes are either Real-time for fast response or RMS for extended programming range. This allows optimal use of programmable output impedance for different applications.

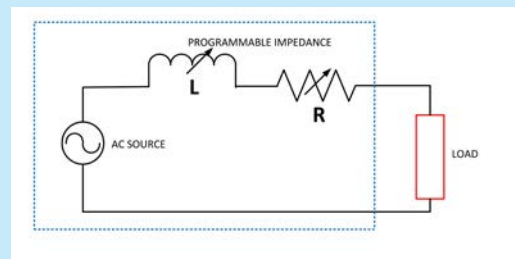

Auxiliary I/O Functions

To support integrated test system design and interaction with the load or other equipment, the AFX Series offers a range of analog and digital I/O functions.

User Programmable I/O. Assign command macros or programming parameters to analog or digital I/O pins as needed. This provides a unique level of customization for putting together sophisticated test stations.

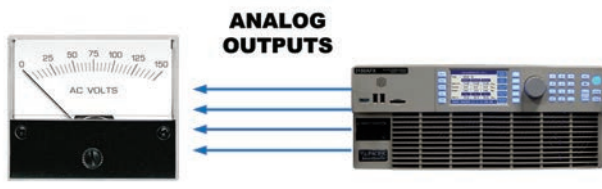
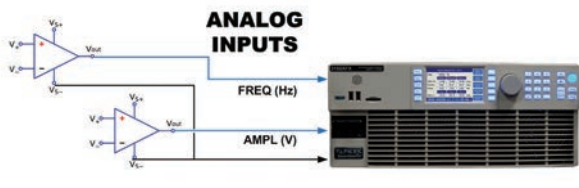
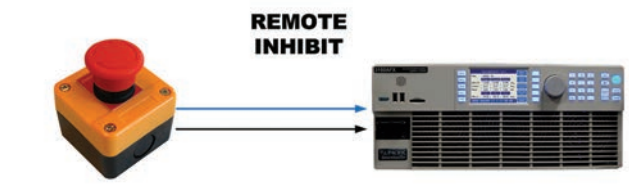
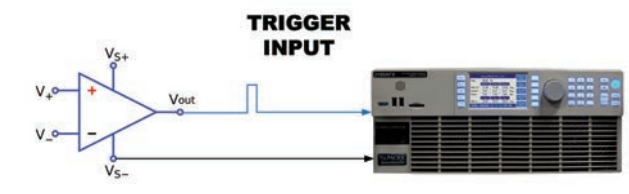
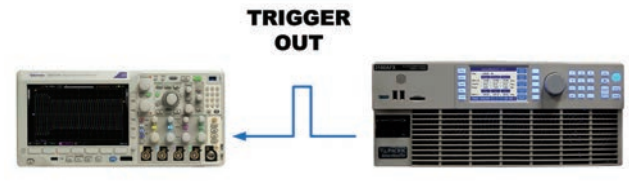

Available Standard Model Configurations

AFX Series AC & DC Sources are available in several power levels. Models listed in the table below are rack mount or bench units. Cabinet systems are pre-wired for both input

and output power. For other configurations or power levels and cabinet options, contact factory. All models shown here require three phase AC input power.

MODEL	Phase Mode	Rated Power ¹ AC / DC mode	Voltage Ranges ² Vac L-N / Vdc	Max. AC/DC Current ² 3 & 2 Phase Mode	Max. AC/DC Current ² 1 Phase Mode ³	Form Factor
360AFX	1, 2 & 3 Phase	6 kVA, kW / 6 kW	0-333 Vac / 0-425Vdc	16.7 Arms / 16.7 Adc	50 Arms / 50.0 Adc	4U Chassis
390AFX	1, 2 & 3 Phase	9 kVA, kW / 9 kW	0-333 Vac / 0-425Vdc	25.0 Arms / 21.0 Adc	75 Arms / 62.5 Adc	4U Chassis
3120AFX	1, 2 & 3 Phase	12 kVA, kW / 12 kW	0-333 Vac / 0-425Vdc	33.3 Arms / 21.0 Adc	100 Arms / 62.5 Adc	4U Chassis
3150AFX	1, 2 & 3 Phase	15 kVA, kW / 15 kW	0-333 Vac / 0-425Vdc	41.7 Arms / 21.0 Adc	125 Arms / 62.5Adc	4U Chassis
3180AFX	1, 2 & 3 Phase	18 kVA, kW / 18 kW	0-333 Vac / 0-425Vdc	50.0 Arms / 41.7 Adc	150 Arms / 125.0 Adc	18U Cabinet
3240AFX	1, 2 & 3 Phase	24 kVA, kW / 24 kW	0-333 Vac / 0-425Vdc	66.7 Arms / 41.7 Adc	200 Arms / 125.0 Adc	18U Cabinet
3300AFX	1, 2 & 3 Phase	30 kVA, kW / 30 kW	0-333 Vac / 0-425Vdc	83.3 Arms / 41.7 Adc	250 Arms / 125.0 Adc	18U Cabinet
3450AFX	1, 2 & 3 Phase	45 kVA, kW / 45 kW	0-333 Vac / 0-425Vdc	125.0 Arms / 62.5 Adc	375 Arms / 187.5 Adc	18U Cabinet
3600AFX	1, 2 & 3 Phase	60 kVA, kW / 60 kW	0-333 Vac / 0-425Vdc	166.7 Arms / 83.3 Adc	500 Arms / 250.0 Adc	28U Cabinet
3750AFX	1, 2 & 3 Phase	75 kVA, kW / 75 kW	0-333 Vac / 0-425Vdc	208.3 Arms / 104 Adc	625 Arms ³ / 312.5 Adc	28U Cabinet
3900AFX	1, 2 & 3 Phase	90 kVA, kW / 90 kW	0-333 Vac / 0-425Vdc	250.0 Arms / 125 Adc	750 Arms ³ / 375.0 Adc	28U Cabinet
Higher	For configurations up to 180kVA/kW, contact factory					

Note 1: Rated power shown is for Three Phase or Single Phase mode operation. For Split Phase mode, rated power is 2/3.

Note 2: Extended Voltage Range Limit. Rated Currents are full specification, nominal values. See specification section for extended operating voltage ranges.

Note 3: Contact factory for cabinet output wiring modifications to support single phase AC mode on cabinets above 60kVA.

Bench, Cabinet Systems or Custom Configurations

The wide range of available power levels combined with the small form factor of the AFX Series allows these power systems to be deployed in small spaces if needed. This feature reduces required floor space and eliminates most load bearing floor issues that can be associated with raised floors. Systems above a 15 kVA power can be shipped pre-installed and pre-wired in standard 19"

heavy duty steel cabinets with casters and levelers for ease of mobility. Cabinet options such as Outlet sockets and Emergency Power Off (EPO) buttons can be ordered as options. Refer to the AFX Cabinet Systems data sheet for available options and configurations. These parallel configurations are also available in **kit form** for system integrators that are planning on using their own cabinets.



Technical Specifications

OUTPUT	Specification
Voltage	
Modes	AC, DC, AC+DC, DC+AC
Nominal Range	AC: 0-300 Vac LN / 0-520Vac LL DC: 0 - 425 Vdc
Extended V Range	0-333 Vac LN / 576 Vac LL (Supplemental specifications)
400V Range Option	See page 14
Programming Resolution	0.01 V
Accuracy	± 0.25% F.S.
Waveforms (200 Max.)	Sine, Square, Triangle, Clipped (THD), Arbitrary
DC Offset	< 20 mV
Harmonic Distortion (Vthd) (full, resistive load, up to 300Vrms L-N)	< 100 Hz < 0.3% 100 Hz to 500Hz < 0.5% 500 to 1000 Hz < 1.0% > 1000 Hz < 1.5%
Output Noise (DC to 300kHz)	< 150 mV RMS
Load Regulation	AC Mode: ± 0.02% (CSC Mode) DC Mode: ± 0.02%
Line Regulation	< 0.1% for 10% Line Change
Voltage Sense	External Sense, max. voltage drop 5% F.S.
Voltage Slew Rate	Programmable: AC > 1.0V/us, DC > 3.0V/us
Output Isolation	550Vac
Frequency	
Nominal Range	DC, 15.00 – 1200.0 Hz
Extended Range ¹	1.00 - 3000.0 Hz
Programming Resolution	0.01 Hz
Accuracy	± 0.01%
Current Limit - RMS and Peak Modes - 3150AFX	
RMS Range	See model table page 11
Crest Factor (data shown for 360AFX~3150AFX)	2.5:1 @ 41.67 to 6.3:1 @ 16.67 (104Apk/phase)
Programming Resolution	0.01 Arms
Accuracy	± 0.5% F.S.
Current Protection (CP) Modes	Constant Current (CC) or Output Trip (CV)
Current Overload Mode	Allows 130% of max. RMS current for up to 2.0 secs before CP is triggered when enabled
Phase Angle (In 3 and 2 Phase Mode)	
Programmable Phase (B, C)	0 - 359.9°
Resolution	0.1°
Programmable Impedance (Per AFX unit, 3 Phs Mode)	
Resistance (R)	RT: ±100Ω / RMS: ±10Ω
Inductance (L)	RT: 0-50μH / RMS: 0-2000μH
PROTECTION	
Available Protections	Over Current fold-back or trip
	Prog. Peak Current Limit
	Power fold-back or trip
	App.Power fold-back or trip
	Over Voltage trip
	Over Temperature trip
OVP Programming Range	0 ~ 105% of voltage range
AC Input Voltage	Over and Under Voltage, 15%

Footnotes:

1: Power restrictions apply below 15Hz and Voltage and Power restrictions apply above 1200Hz.

TRANSIENTS	Specification
Programming	
No. of Entries	200 Steps / 400 segments
Modes	LIST, PULSE, STEP
Parameters	Frequency, Volt AC, Volt DC, Waveform, Ramp Time, Dwell Time
Dwell Time Range	0.1 - 10000000.0 msec
Time Resolution	0.2 msec
Edit Modes	Add at end, Insert before, Delete
Execution	
Run Control	Run from step # to step # Run, Step, Restart, Stop
Execution Modes	Normal, Debug
Program Storage	
Non-volatile	100 Programs + Transients

MEASUREMENTS	Specification
Voltage (Vrms)	
Range ²	0 – 350 VLN / 0-600 VLL
Resolution	FP: 10 mV / Bus: 1 mV
Accuracy	± 0.25% F.S.
Current (Arms)	
Range	See model table page 11
Resolution	FP: 10 mA / Bus: 1 mA
Accuracy ³	± 0.5% F.S.
Current Crest Factor	
Range	1.00 - 5.00
Resolution	FP: 0.01 / Bus: 0.001
Accuracy ³	± 2.0% F.S.
Power (kW)	
Range	See model table page 11
Resolution	FP: 1 W / Bus: 0.1 W
Accuracy ⁴	± 1.5 % F.S.
Apparent Power (kVA)	
Range	See model table page 11
Resolution	FP: 1 VA / Bus: 0.1 VA
Accuracy ⁴	± 1.5 % F.S.
Power Factor	
Range ⁴	0.00 - 1.00
Resolution	FP: 0.01 / Bus: 0.001
Voltage (Vdc)	
Range ⁵	0 – 440 Vdc
Resolution	FP: 10 mV / Bus: 1 mV
Accuracy	± 0.25% F.S.
Current (Adc)	
Range	See model table page 11
Resolution	FP: 10 mA / Bus: 1 mA
Accuracy ³	± 0.5% F.S.

Footnotes:

2: Voltage range is re-scaled as needed when T Option unit is connected

3: For RMS Currents above 2.0 A

4: For Power levels above 100 W

5: Range = 0 - 880 Vdc in Split phase mode

Technical Specifications (continued)



AC INPUT	6 kVA	9 kVA	12 kVA	15 kVA ⁵
Mains Voltage Form	4 Wire, L1, L2, L3 and PE			
Frequency	47 - 63 Hz			
-2 AC Input Versions				
Input Voltage Range	208Vac – 240Vac ± 10%			
Nominal Phase Current ¹	23 Arms	33 Arms	43 Arms	51 Arms
Peak Inrush Current ²	< 1.5 x Irms			
Input Power Factor	> 0.9			
Efficiency	> 85%			
-4 AC Input Versions				
Input Voltage Range	380Vac – 480Vac ± 10%			
Nominal Phase Current ³	13 Arms	18 Arms	24 Arms	27 Arms
Nominal Phase Current ⁴	11 Arms	14 Arms	20 Arms	23 Arms
Peak Inrush Current ²	< 1.5 x Irms			
Input Power Factor	> 0.9			
Efficiency	> 85%			

Footnotes:

- 1: For nominal 3ø, 208V input voltage 3: For nominal 380V input voltage
 2: Irms = AC input current @ rated power 4: For nominal 480V input voltage
 5: For systems above 15 kVA, input current is multiplied by the number of units

ENVIRONMENTAL	Specification
Cooling	Variable speed fan cooled, front intake, rear exhaust
Audible Noise: At 1 meter distance	Standby: 46 dBA Full power: 85 dBA typical
Sleep Modes	Standby, All Power Stages off
Temperature	
Operating	0 to 40 °C / 32 to 104 °F
Storage	-20 to 70 °C / -4 to 158 °F
Humidity	< 80%, non-condensing
Altitude	2000 m / 6500 feet



SYSTEM FEATURES	Description
DISPLAY	
Type	Full Color, Touch LCD Display
Size	4.3" Diagonal
Resolution	480 x 272 pixels
USB Ports	2 Front Panel, 1 Rear Panel, Type A
SD Card	32 GB max. Capacity
Video Output	Monitor Out, Front Panel

INTERFACES	Description
Remote Control	
USB	Device Type B
RS232	1200 - 921600 baud
LAN	LXI compliant, Ethernet, RJ45, TCP/IP Protocol, Telnet Protocol Command Line
LXI Compliant	 LAN eXtensions for Instrumentation
GPIB (G)	IEEE488.1, IEEE488.2 (2003 incl., NI HS488) IEC 60488-1, IEC 60488-2 (2004) Functions: SH1, AH1, T6, L3, SR1, RL1, DC1, DT1
WiFi	Optional USB WiFi adaptor available 

ANALOG I/O	Specification
Analog Inputs (4)	
AI1, AI2, AI3	Voltage setting phs A, B, C
AI4	Frequency
Range	0 - 10 Vdc for 0 - F.S.
Accuracy	± 0.1% F.S.
Impedance	10 kOhm
Analog Outputs (4)	
AO1, AO2, AO3	Voltage Meas. phs A, B, C
AO4	Power Measurement Total
Range	0 - 10Vdc for 0 - F.S.
Accuracy	± 0.1% F.S. into > 5 kOhm load
Impedance	5 kOhm
Connector Type	DB25, Rear Panel

DIGITAL I/O	Specification
Digital Inputs (6)	
Fixed (3)	Remote Inhibit, Transient Trigger, Phase Sync
User Programmable (3)	DI1, DI2, DI3
Input Levels	Low < 0.4V, High > 2.0V
Digital Outputs (6)	
Open Collector, Fixed (2)	Relay Control FORM, Relay Control T Option
TTL, Fixed (2)	Output Relay/Transient /Function Strobe Phase Sync
User Programmable (2)	DO1, DO2
Output Levels	Low < 0.4V, High > 4.6V
Connector Type	DB25, Rear Panel

DIMENSIONS / WEIGHT	Specification
Dimensions Bench Models up to 15 kVA (4U)	
H x W x D	7.0" x 17.0" x 25.0" 178 x 432 x 635 mm See Note 1 below
Shipping H x W x D	20" x 27" x 38" 508 x 686 x 965 mm
Weight Models up to 15 kVA	
Net	111.2 lbs. / 50.4 kg
Shipping	151 lbs / 68.5 kg
<i>Note 1: Units can be zero-stacked in 19" EIA cabinet when using optional rack-slides. When using L-brackets, allow 1U space between units.</i>	

REGULATORY	Specification
Safety	
Standard	IEC 61010-1:2010 (Edition 3)
EMC	
Emissions Standard	EN 55011:2009+A1:2010
Immunity Standard	EN 61000-4-2, -3, -4, -5, -6, -8, -11
Product Category	EN 61326-1:2013 (Measurement, Laboratory and Control Equipment)
Approvals	CE Mark, NTRL Nemko US/Canada
	 
RoHS (DIRECTIVE 2011/65/EU)	
Product Category	EN50581:2012

High Voltage Output Transformer (T Option)

If 333Vac LN / 576Vac LL is not sufficient, the AFX power source can be equipped with an optional output Transformer module. For power levels up to 15kVA/kW, a single 4U matching AFX style chassis is added. This chassis contains three step-up transformers, one for each phase. With this T option, an additional AC only mode range is added to the AFX capable of supporting the following output voltage ranges depending on phase mode:

Single Phase **Split Phase** **Three Phase**
 0-400 VL-N 0-800 VL-L 0-400 VL-N/0-692 VL-L

Standard AC and DC voltage ranges remain available. For voltages higher than 400VL-N, contact factory.

Full Frequency Range

The transformer does not reduce the available output power from 45Hz to 1000Hz. Maximum voltage is reduced linearly from 45Hz down to 15Hz¹ and max. current from 1000Hz to 1200Hz. Selecting the AC high voltage range is controlled from the front panel or using SCPI commands over one of the remote control interface.

Constant Power Mode

The 400V transformer range has a constant power profile. That means full power is available all the way down to 160 Vac L-N/277 Vac L-L on the 400V range. See profiles below.



3150AFX Shown with **Optional** 4U T-Option Chassis

Voltage Sense

The voltage sense on the 400Vac range is connected to the secondary side of the output transformer and re-scales automatically for the higher voltage range limit. This ensures optimal voltage accuracy at the load despite the higher voltage range and compensates for any transformer impedance induced load regulation errors.

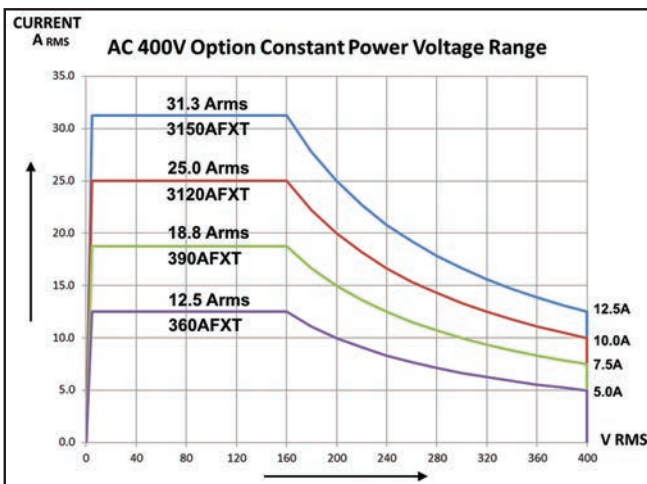

Three Phase Mode 400 V Range Constant Power Profile

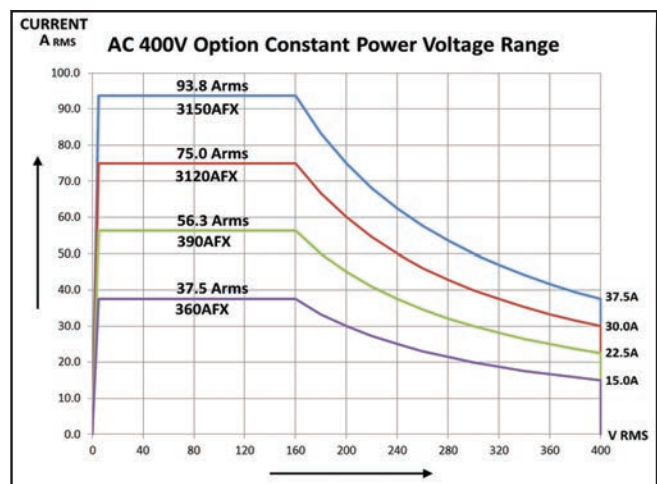

Single Phase Mode 400 V Range Constant Power Profile

T Option - Technical Specifications

ELECTRICAL	Specification
Output Mode	AC Only. No DC or AC+DC modes on T Option range
Voltage Range	0-400 Vac LN / 0-692Vac LL
Resolution	0.01 V
Accuracy	± (0.25% + 0.25* f (kHz)) F.S.
Voltage Sense	Auto scales for T option range
Frequency Range	45Hz - 1000Hz Deratings: Voltage < 45Hz, Current > 1000Hz
Constant Power Mode	From 40% to 100% of V range

MECHANICAL	Specification
Mechanical - T Option Chassis (15kVA rated)	
H x W x D	7.0" x 17.0" x 25.0" 178 x 482 x 635 mm
Weight	170 lbs. / 77.1 kg
Mechanical - Cabinet Systems	
Dimensions / Weight	Refer to AFX Cabinet Systems data sheet

Note 1: Extended frequency ranges are not supported on this optional AC coupled voltage range.

Ordering Information

Standard Models and Cabinet Systems (Refer to Model Number Encoder below)

Bench Models <input type="checkbox"/> 360AFX <input type="checkbox"/> 390AFX <input type="checkbox"/> 3120AFX <input type="checkbox"/> 3150AFX	Cabinet Systems¹ <input type="checkbox"/> 3180AFX <input type="checkbox"/> 3600AFX <input type="checkbox"/> 3240AFX <input type="checkbox"/> 3750AFX <input type="checkbox"/> 3300AFX <input type="checkbox"/> 3900AFX <input type="checkbox"/> 3450AFX Systems available up to 180kVA	Output Transformer Options <input type="checkbox"/> T Suffix - 400V Option Consult factory for other voltage ranges Note: 4U Transformer Chassis is not included on 360AFX, 390AFX, 3120AFX & 3150AFX single chassis models and must be added as a line item.	Master Unit with front panel controller <input type="checkbox"/> A Controller w/Analog & Digital I/O <input type="checkbox"/> G GPIB Interface
Auxiliary Models (No controller) <input type="checkbox"/> 390AFX-2NC / 390AFX-4NC <input type="checkbox"/> 3120AFX-2NC / 3120AFX-4NC <input type="checkbox"/> 3150AFX-2NC / 3150AFX-4NC	Input Voltage (V_{IN}) <input type="checkbox"/> -2 208V - 240Vac, 3Ø ± 10%, 47-63Hz <input type="checkbox"/> -4 380V - 480Vac, 3Ø ± 10%, 47-63Hz	Options <input type="checkbox"/> C IEC413 Interharmonics Generator <input type="checkbox"/> O OCS Output Control Switch <input type="checkbox"/> DM Dual Master (45kVA or higher models only)	Export Version <input type="checkbox"/> E Append "E" postfix

AFX Series Model Number Encoder:

Note: Solid outlined fields must be specified. Dashed outlined fields are optional.

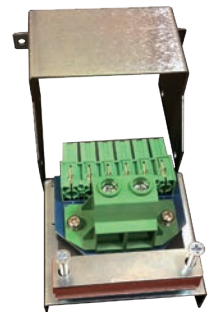
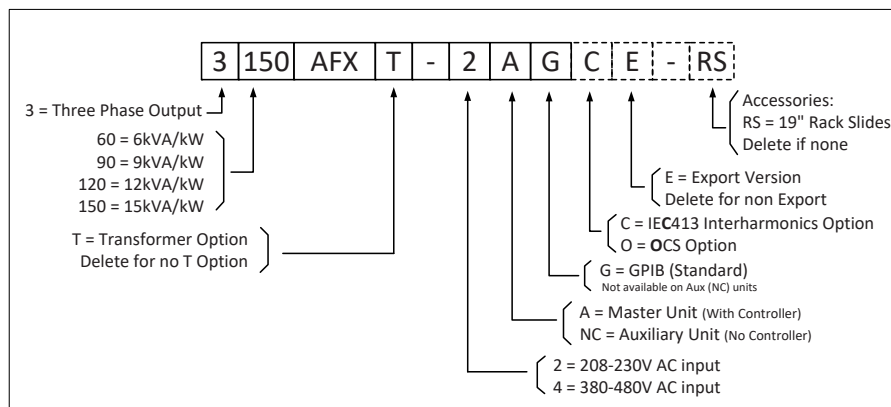

Single Phase Mode Output Adaptor Option

Order Example

- 3150AFX-2AG
- Bench Model, 15 kVA, 3-Phase, AC Power Source with USB, RS232, LAN, GPIB & AUX I/O
 - 208Vac 3 Phase Input Voltage

Typical Delivery Items

- AC Power Source
- English Manuals in PDF Format
- Rack Mount Handles
- Certificate of Compliance

Available Accessories

- Output shorting adaptor for single phase output mode use. P/N 160086 (see pic.)
- Paralleling Cable, 1 Ft. (Included with Aux models). P/N 778036
- Rack slides. P/N 703251

Note 1: Cabinet systems consist of one master unit and one or more auxiliary units integrated into a 19 inch EIA instrument grade cabinet. Includes input and output wiring to rear mounted compression terminal blocks. Shown with optional Emergency Power Off (EPO). Other cabinet options available. Customers that require the use of their own cabinets can order system packages without cabinet. Contact factory for ordering information.

Software Options

Windows 10 Software - 64 Bit <input type="checkbox"/> PPSC Studio Control Software <input type="checkbox"/> PPSC Test Manager	Test Sequences - Avionics² <input type="checkbox"/> ABD0100.1.8 - Airbus A380, AC & DC Power Groups <input type="checkbox"/> ABD0100.1.8.1 - Airbus A350, AC & DC Power Groups <input type="checkbox"/> AMD24C - Airbus A400M, AC & DC Power Groups <input type="checkbox"/> Boeing 787B3-0147 - B787, AC & DC Power Groups <input type="checkbox"/> MIL-STD704 - US DoD, AC & DC Power Groups <input type="checkbox"/> RTCA-DO160 Section 16, AC & DC Power Groups	Test Sequences - Other² <input type="checkbox"/> IEC Test Suite - Includes IEC 61000-4-11, IEC 61000-4-14, IEC 61000-4-27, IEC 61000-4-28, IEC 61000-4-29p and IEC 61000-4-34 <input type="checkbox"/> MIL-STD 1399-300B - US DoD, Ship-board Power, AC Power Groups
--	---	--

Note 2: Test Sequence Options require PPSC Studio and PPSC Test Manager license.



Unit Dimensions¹

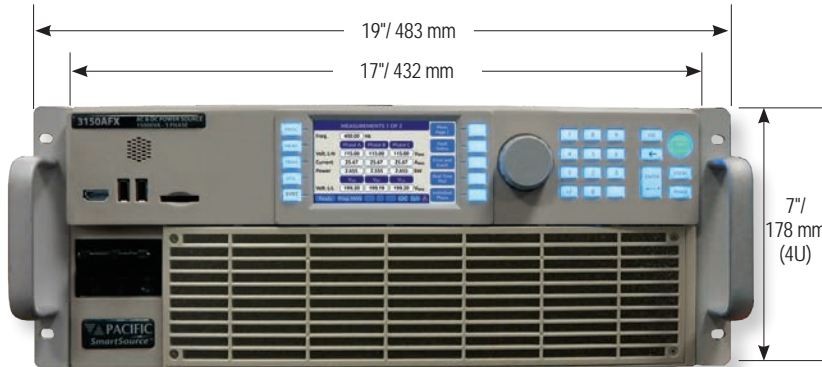

The 3150AFX is designed for bench top or 19" equipment rack operation. Shown with included rack mount handles.

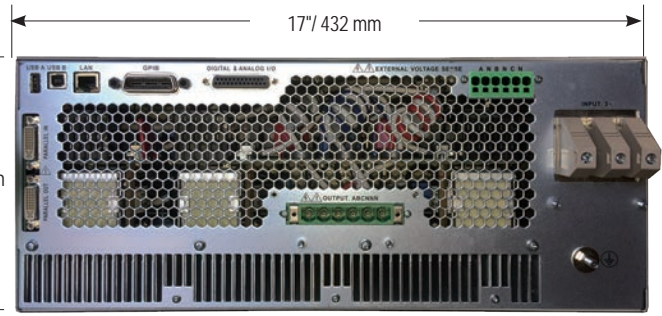

The AFX Rear Panel provides connections for AC Input, AC or DC Output, External Sense, Aux I/O and remote control interfaces. Shown with standard GPIB Interface

Note 1: Units can be zero-stacked in 19" EIA cabinet when using optional rack-slides. When using L-brackets, allow 1U space between units.

Service and Support

Pacific Power Source's customer support is second to none. Our Customer Support Program provides the training, repair, calibration, and technical support services that our customers value. In addition to receiving the right test equipment, our customers can also count on excellent support before, during and after the sale. With company owned support and service centers around the world, support is never far away. Complete calibration and repair services are offered at our US, European and Chinese manufacturing facilities (see contact info below). Calibrations are to original factory specifications and are traceable to NIST (National Institute of Standards and Technology).

NORTH AMERICA

Pacific Power Source, Inc.
Irvine, USA
Phone: +1(949) 251-1800
Fax: +1 (949) 756-0756
Sales: sales@pacificpower.com
Service: support@pacificpower.com

EUROPE

Caltest Instruments Ltd.
Guildford, United Kingdom
Phone: +44(0)1483 302 700
Fax: +44(0)1483 300 562
Sales: sales@pacificpower.com
Service: support@pacificpower.com

CHINA

PPST Shanghai Co. Ltd.
Shanghai, China
Phone: +86-21-6763-9223
Fax: +86-21-5763-8240
Sales: sales@pacificpower.com
Service: support@pacificpower.com

Proudly Represented by:



17692 Fitch, Irvine, CA 92614 USA
Phone: +1 949.251.1800
Fax: +1 949.756.0756
Toll Free: 800.854.2433
E-mail: sales@pacificpower.com
www.pacificpower.com